

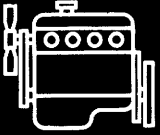



















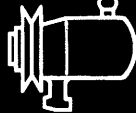













- 0 
- 1 
- 2    
- 3   
- 4  
- 5  
- 6   
- 7 
- 8 
- 9   
- 10 
- 11  
- 12   
- 13   
- 14   
- 15   





10



MA  
440.00/1

1

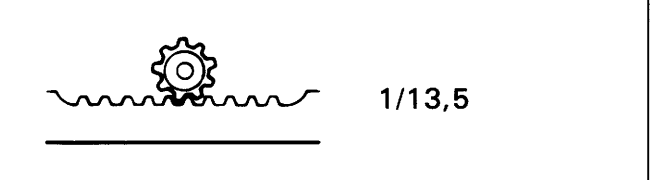
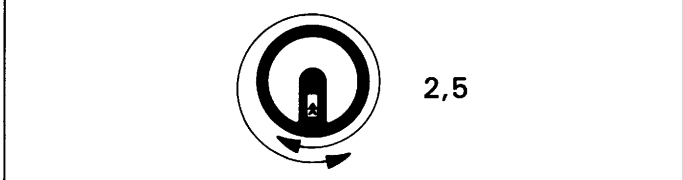
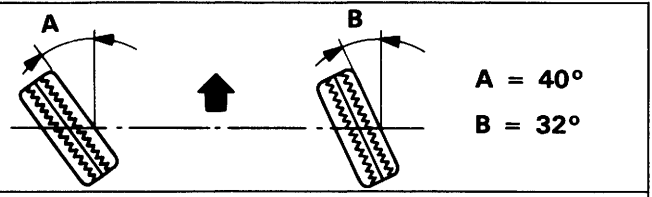
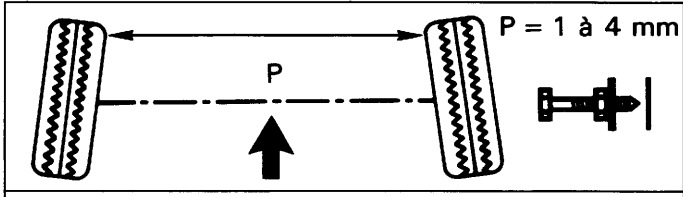
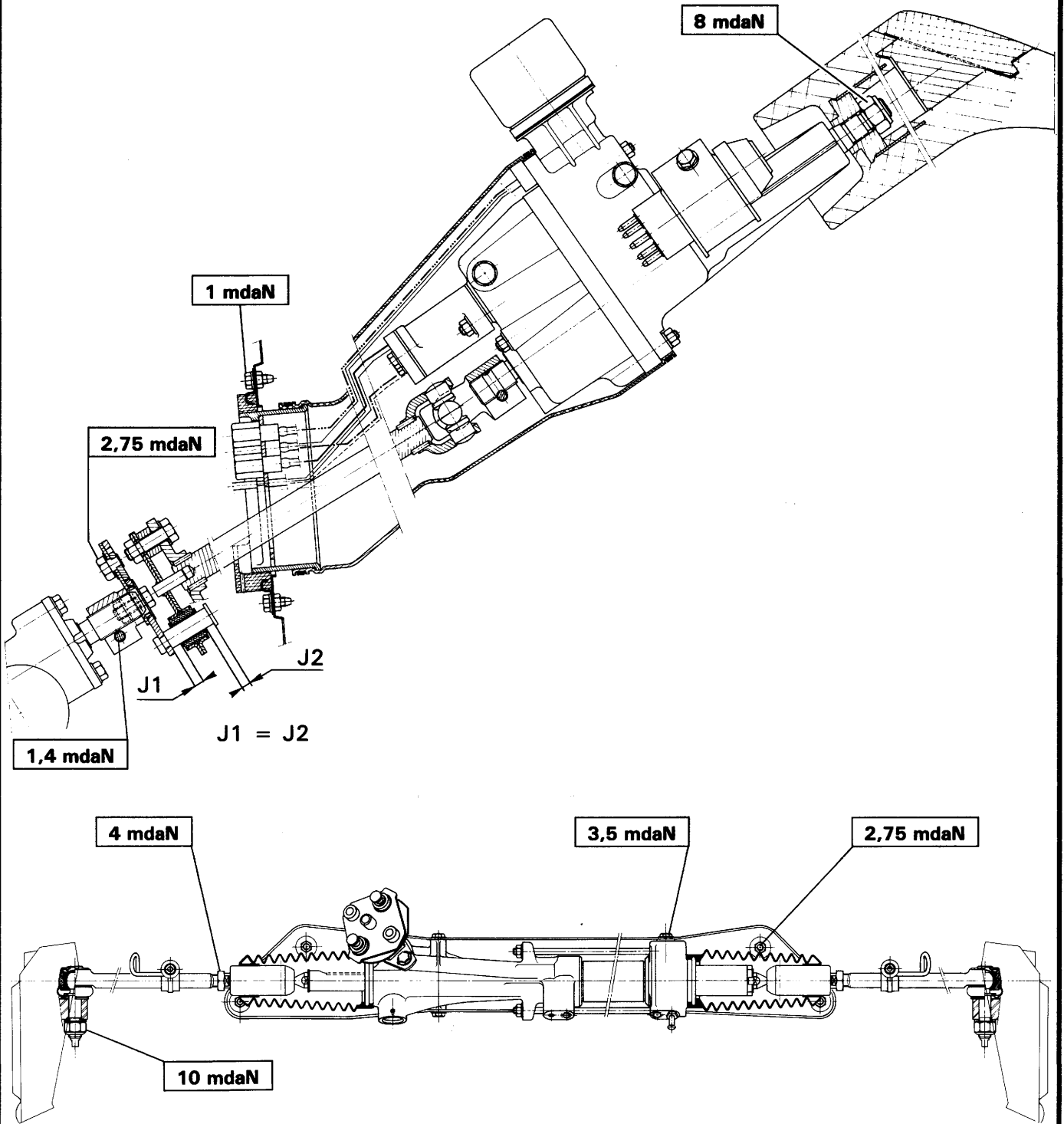

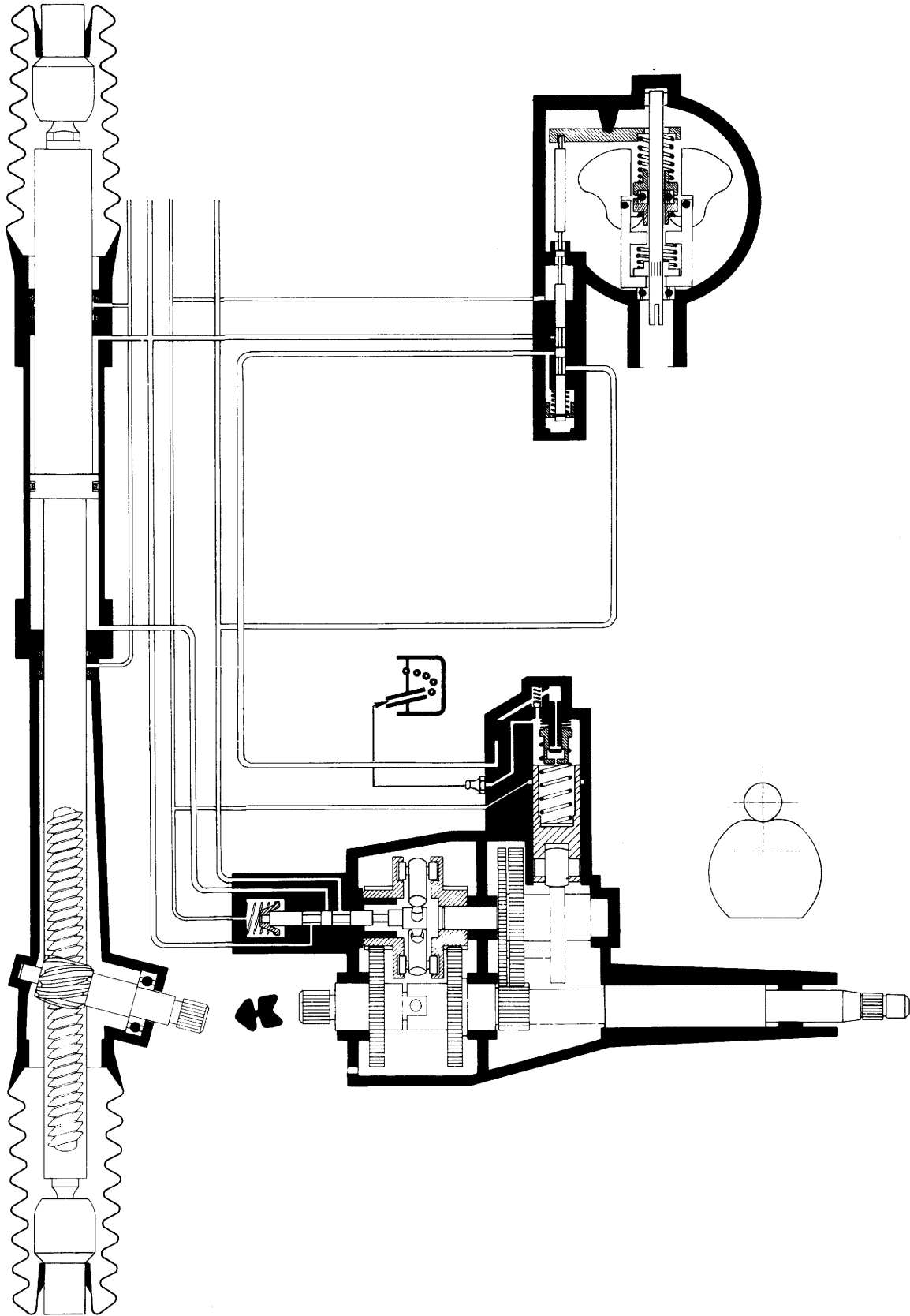



10



MA  
440.00/1

3

